

# MASW-005102-13600

**HMIC™ Silicon PIN Diode Switch  
with Integrated Bias Network**

**RoHS Compliant**

**M/A-COM Products**

## Features

- ◆ Broad Bandwidth Specified up to 18 GHz
- ◆ Usable up to 26 GHz
- ◆ Integrated Bias Network
- ◆ Low Insertion Loss / High Isolation
- ◆ Rugged, Glass Encapsulated Construction
- ◆ Fully Monolithic

## Description

The MASW-005102-13600 device is a SP5T broadband switch with integrated bias network utilizing M/A-COM's HMIC™ (Heterolithic Microwave Integrated Circuit) process, US Patent 5,268,310. This process allows the incorporation of silicon pedestals that form series and shunt diodes or vias by imbedding them in low loss, low dispersion glass. By using small spacing between elements, this combination of silicon and glass gives HMIC devices low loss and high isolation performance with exceptional repeatability through low millimeter frequencies. Large bond pads facilitate the use of low inductance ribbon bonds, while gold backside metallization allows for manual or automatic chip bonding via 80/20 - Au/Sn, 62/36/2 - Sn/Pb/Ag solders or electrically conductive silver epoxy.

## Applications

These high performance switches are suitable for use in multi-band ECM, Radar, and instrumentation control circuits where high isolation to insertion loss ratios are required. With a standard +5V/-5V, TTL controlled PIN diode driver, 80nS switching speeds can be achieved.

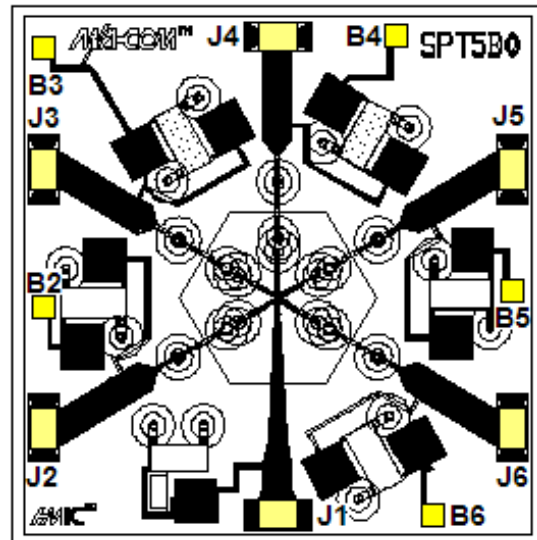

**Yellow areas denote wire bond pads**

Parameter	Absolute Maximum
Operating Temperature	-65°C to +125°C
Storage Temperature	-65°C to +150°C
Junction Temperature	+175°C
Applied Reverse Voltage	50V
RF Incident Power	+33dBm C.W. <sup>1</sup>
Bias Current +25°C	±20mA

**Note:**

1. Maximum operating conditions for a combination of RF power, D.C. bias and temperature:

**ADVANCED:** Data Sheets contain information regarding a product M/A-COM is considering for development. Performance is based on target specifications, simulated results, and/or prototype measurements. Commitment to develop is not guaranteed.

**PRELIMINARY:** Data Sheets contain information regarding a product M/A-COM has under development. Performance is based on engineering tests. Specifications are typical. Mechanical outline has been fixed. Engineering samples and/or test data may be available. Commitment to produce in volume is not guaranteed.

- **North America** Tel: 800.366.2266 / Fax: 978.366.2266
- **Europe** Tel: 44.1908.574.200 / Fax: 44.1908.574.300
- **Asia/Pacific** Tel: 81.44.844.8296 / Fax: 81.44.844.8298

Visit [www.macom.com](http://www.macom.com) for additional data sheets and product information.

M/A-COM Inc. and its affiliates reserve the right to make changes to the product(s) or information contained herein without notice.

# MASW-005102-13600

**HMIC™ Silicon PIN Diode Switch  
with Integrated Bias Network**

**RoHS Compliant**

**M/A-COM Products**

## MASW-005102-13600 (SP5T) Electrical Specifications @ T<sub>AMB</sub> = +25°C, 10mA Bias current

PARAMETER	FREQUENCY BAND	MIN	TYP	MAX	UNITS
INSERTION LOSS	2GHz			1.5	dB
	6GHz		0.9	1.0	dB
	12GHz		1.2	1.5	dB
	18GHz		1.8	2.1	dB
ISOLATION	2GHz	45	50		dB
	6GHz	40	48		dB
	12GHz	30	40		dB
	18GHz	25	35		dB
INPUT RETURN LOSS	6GHz		20		dB
	12GHz		20		dB
	18GHz		17		dB
OUTPUT RETURN LOSS	2GHz		22		dB
	6GHz		19		dB
	12GHz		19		dB
	18GHz		17		dB
SWITCHING SPEED	10GHz		80		ns

**Note:**

1. Typical switching speed measured from 10% to 90% of detected RF signal driven by TTL compatible drivers using RC output spiking network, R = 50 – 200Ω , C = 390 – 560pF.

### Operation of the MASW-005102-13600

Operation of the MASW Series of PIN switches is achieved by the simultaneous application of negative DC current to the low loss port and positive DC current to the remaining isolated switching ports per the Driver Connections table below. The control currents should be supplied by constant current sources. For insertion loss, -10mA bias results in approximately -2V, and for Isolation ,+10mA yields approximately +0.9V at the respective bias nodes. The backside area of the die is the RF and DC return ground plane.

### Driver Connections

CONTROL LEVEL (DC CURRENT)					CONDITION OF RF OUTPUT				
B2	B3	B4	B5	B6	J2-J1	J3-J1	J4-J1	J5-J1	J6-J1
-10mA	+10mA	+10mA	+10mA	+10mA	<b>Low Loss</b>	Isolation	Isolation	Isolation	Isolation
+10mA	-10mA	+10mA	+10mA	+10mA	Isolation	<b>Low Loss</b>	Isolation	Isolation	Isolation
+10mA	+10mA	-10mA	+10mA	+10mA	Isolation	Isolation	<b>Low Loss</b>	Isolation	Isolation
+10mA	+10mA	+10mA	-10mA	+10mA	Isolation	Isolation	Isolation	<b>Low Loss</b>	Isolation
+10mA	+10mA	+10mA	+10mA	-10mA	Isolation	Isolation	Isolation	Isolation	<b>Low Loss</b>

**ADVANCED:** Data Sheets contain information regarding a product M/A-COM is considering for development. Performance is based on target specifications, simulated results, and/or prototype measurements. Commitment to develop is not guaranteed.

**PRELIMINARY:** Data Sheets contain information regarding a product M/A-COM has under development. Performance is based on engineering tests. Specifications are typical. Mechanical outline has been fixed. Engineering samples and/or test data may be available. Commitment to produce in volume is not guaranteed.

- **North America** Tel: 800.366.2266 / Fax: 978.366.2266
- **Europe** Tel: 44.1908.574.200 / Fax: 44.1908.574.300
- **Asia/Pacific** Tel: 81.44.844.8296 / Fax: 81.44.844.8298

Visit [www.macom.com](http://www.macom.com) for additional data sheets and product information.

*M/A-COM Inc. and its affiliates reserve the right to make changes to the product(s) or information contained herein without notice.*

# MASW-005102-13600

**HMIC™ Silicon PIN Diode Switch  
with Integrated Bias Network**

**RoHS Compliant**

**M/A-COM Products**

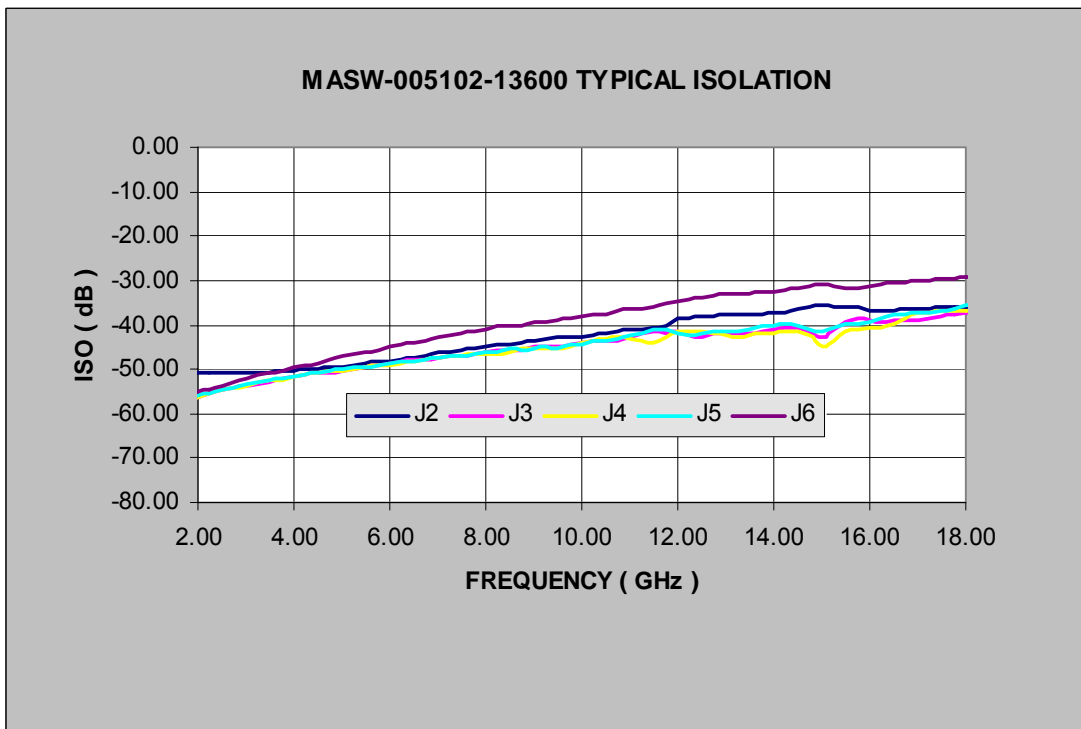
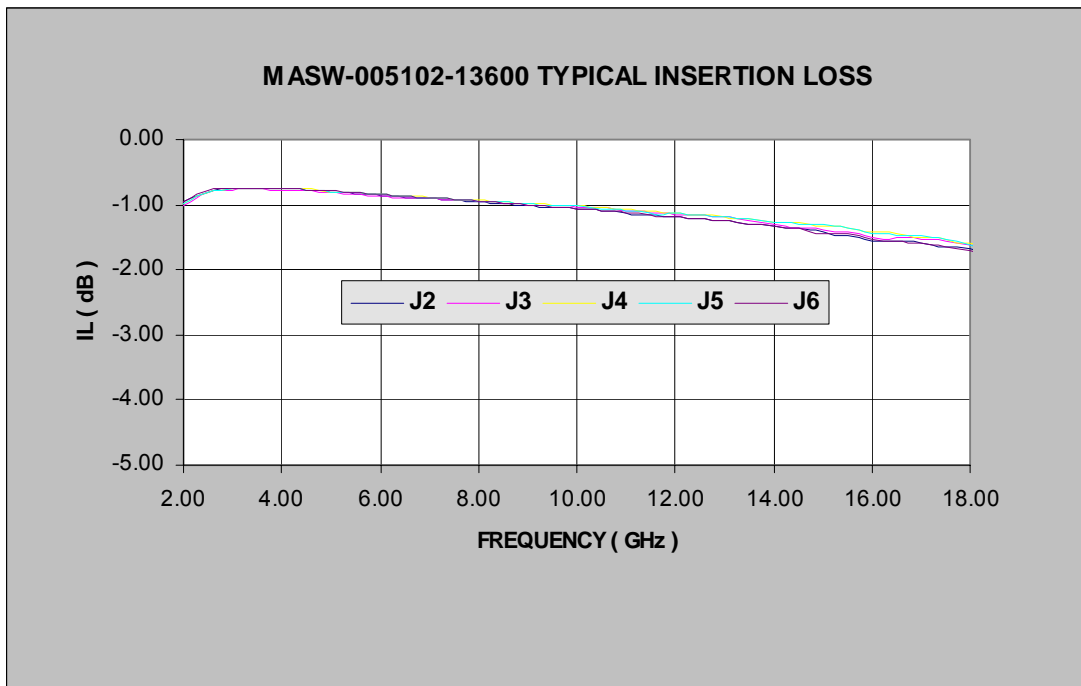

**ADVANCED:** Data Sheets contain information regarding a product M/A-COM is considering for development. Performance is based on target specifications, simulated results, and/or prototype measurements. Commitment to develop is not guaranteed.

**PRELIMINARY:** Data Sheets contain information regarding a product M/A-COM has under development. Performance is based on engineering tests. Specifications are typical. Mechanical outline has been fixed. Engineering samples and/or test data may be available. Commitment to produce in volume is not guaranteed.

- **North America** Tel: 800.366.2266 / Fax: 978.366.2266
- **Europe** Tel: 44.1908.574.200 / Fax: 44.1908.574.300
- **Asia/Pacific** Tel: 81.44.844.8296 / Fax: 81.44.844.8298

Visit [www.macom.com](http://www.macom.com) for additional data sheets and product information.

*M/A-COM Inc. and its affiliates reserve the right to make changes to the product(s) or information contained herein without notice.*

# MASW-005102-13600

**HMIC™ Silicon PIN Diode Switch  
with Integrated Bias Network**

**RoHS Compliant**

**M/A-COM Products**

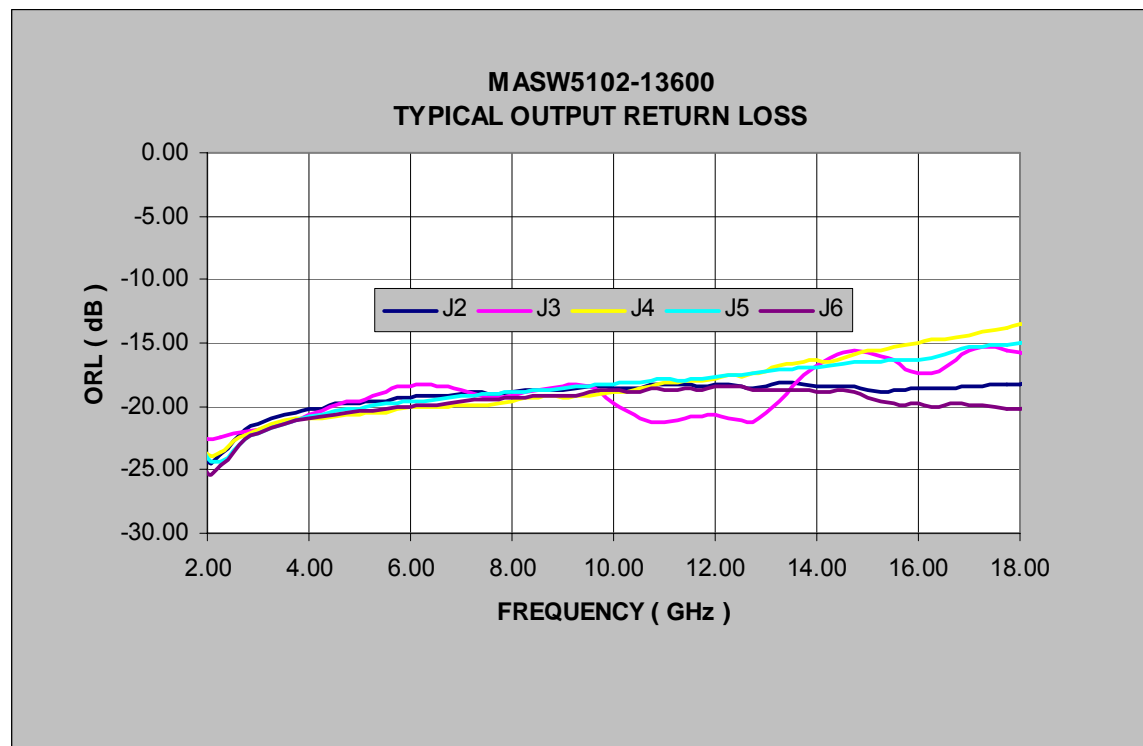
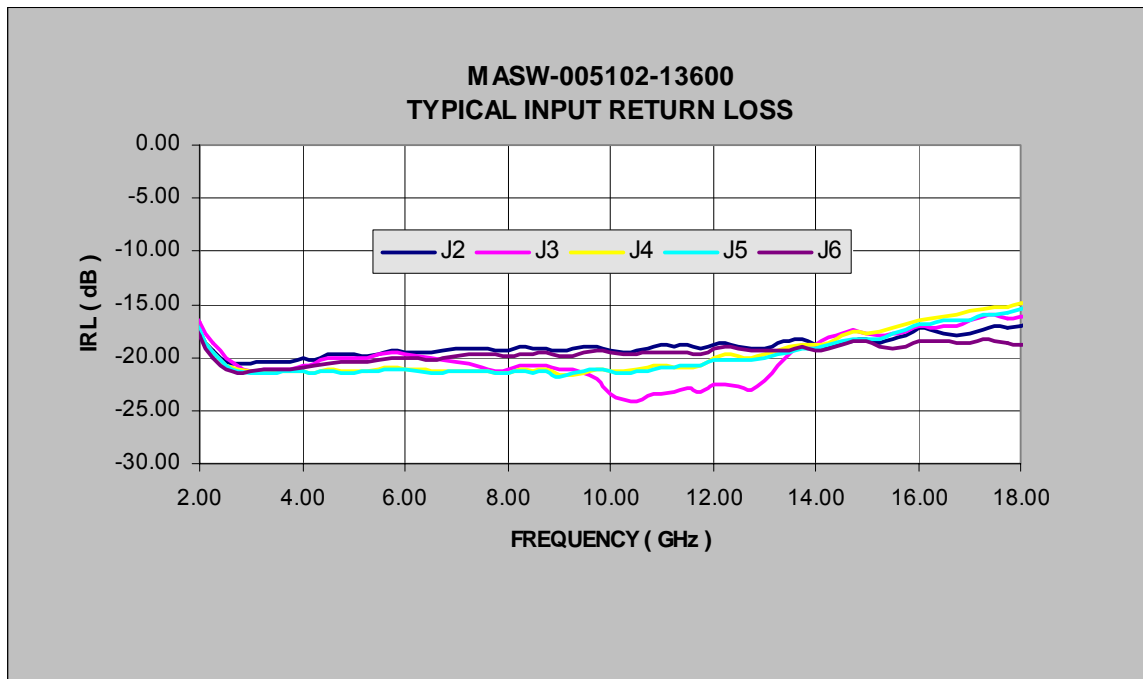

**ADVANCED:** Data Sheets contain information regarding a product M/A-COM is considering for development. Performance is based on target specifications, simulated results, and/or prototype measurements. Commitment to develop is not guaranteed.

**PRELIMINARY:** Data Sheets contain information regarding a product M/A-COM has under development. Performance is based on engineering tests. Specifications are typical. Mechanical outline has been fixed. Engineering samples and/or test data may be available. Commitment to produce in volume is not guaranteed.

- **North America** Tel: 800.366.2266 / Fax: 978.366.2266
- **Europe** Tel: 44.1908.574.200 / Fax: 44.1908.574.300
- **Asia/Pacific** Tel: 81.44.844.8296 / Fax: 81.44.844.8298

Visit [www.macom.com](http://www.macom.com) for additional data sheets and product information.

M/A-COM Inc. and its affiliates reserve the right to make changes to the product(s) or information contained herein without notice.

**MASW-005102-13600 Schematic**

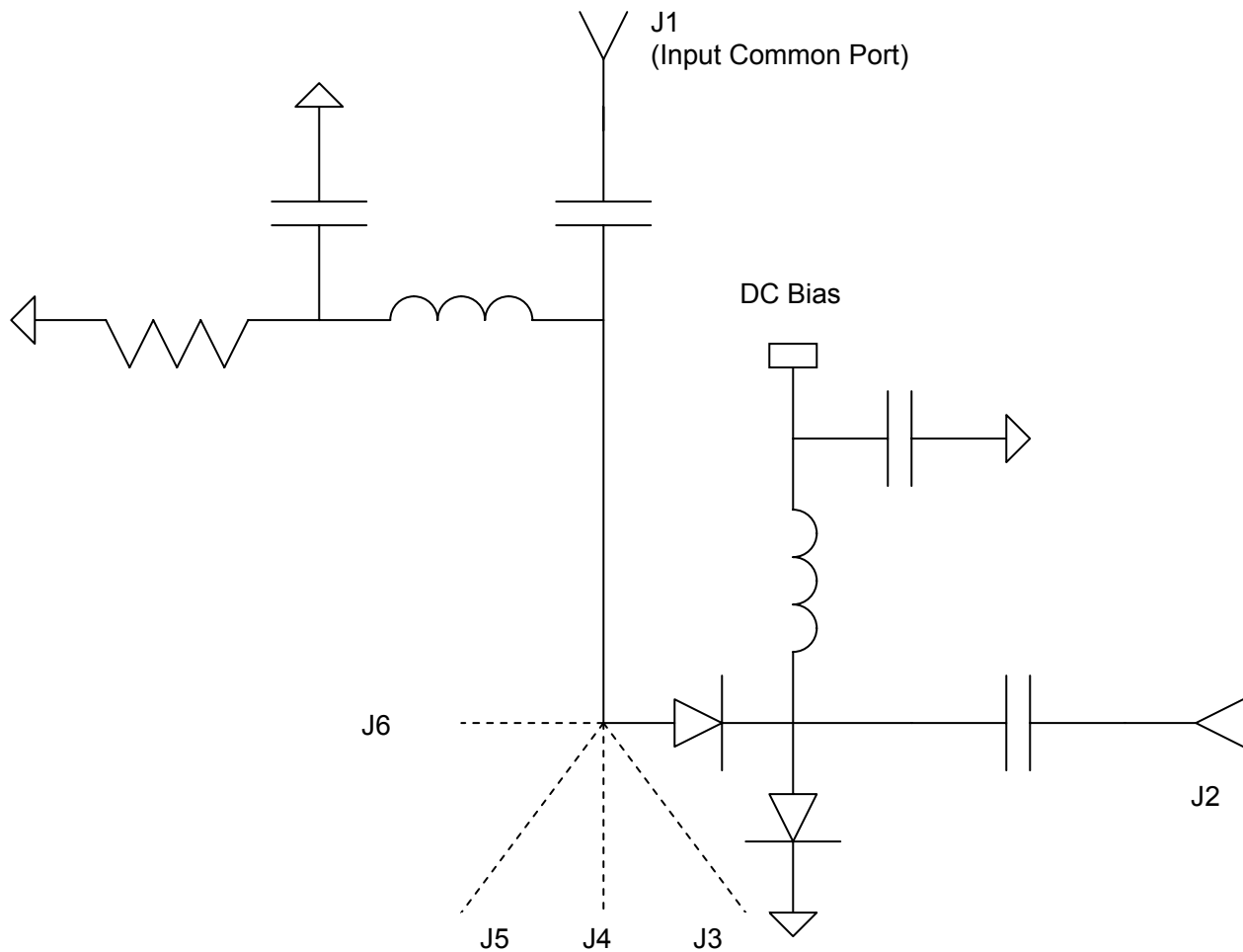

**ADVANCED:** Data Sheets contain information regarding a product M/A-COM is considering for development. Performance is based on target specifications, simulated results, and/or prototype measurements. Commitment to develop is not guaranteed.  
**PRELIMINARY:** Data Sheets contain information regarding a product M/A-COM has under development. Performance is based on engineering tests. Specifications are typical. Mechanical outline has been fixed. Engineering samples and/or test data may be available. Commitment to produce in volume is not guaranteed.

- **North America** Tel: 800.366.2266 / Fax: 978.366.2266
- **Europe** Tel: 44.1908.574.200 / Fax: 44.1908.574.300
- **Asia/Pacific** Tel: 81.44.844.8296 / Fax: 81.44.844.8298

Visit [www.macom.com](http://www.macom.com) for additional data sheets and product information.

M/A-COM Inc. and its affiliates reserve the right to make changes to the product(s) or information contained herein without notice.

MASW-005102-13600

HMIC™ Silicon PIN Diode Switch  
with Integrated Bias Network

RoHS Compliant

M/A-COM Products

MASW-005102-13600  
Chip Outline Drawing<sup>1,2</sup>

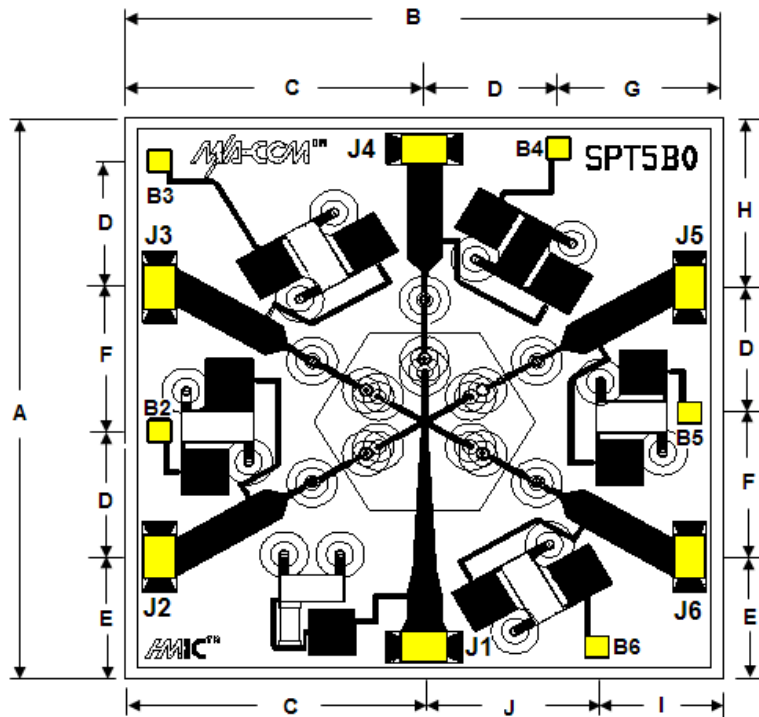

DIM	INCHES		MILLIMETERS	
	MIN	MAX	MIN	MAX
A	0.120	0.122	3.048	3.099
B	0.120	0.122	3.048	3.099
C	.0595	.0605	1.511	1.537
D	.0275	.0285	0.699	0.724
E	.0250	.0265	0.635	0.673
F	.0315	.0325	0.800	0.826
G	.0325	.0335	0.826	0.851
H	.0355	.0365	0.902	0.927
I	.0245	.0255	0.622	0.648
J	.0345	.0355	0.876	0.902
RF Bond Pads (J1-J6)	.007 X .005 REF.		.170 X .120 REF.	
DC Bond Pads (B2-B5)	.005 X .005 REF.		.125 X .125 REF.	
Thickness	0.005 REF.		0.125 REF.	

**Notes:**

1. Topside and backside metallization is gold , 2.5mm thick typical.
2. Yellow areas indicate wire bonding pads

**ADVANCED:** Data Sheets contain information regarding a product M/A-COM is considering for development. Performance is based on target specifications, simulated results, and/or prototype measurements. Commitment to develop is not guaranteed.

**PRELIMINARY:** Data Sheets contain information regarding a product M/A-COM has under development. Performance is based on engineering tests. Specifications are typical. Mechanical outline has been fixed. Engineering samples and/or test data may be available. Commitment to produce in volume is not guaranteed.

- **North America** Tel: 800.366.2266 / Fax: 978.366.2266
- **Europe** Tel: 44.1908.574.200 / Fax: 44.1908.574.300
- **Asia/Pacific** Tel: 81.44.844.8296 / Fax: 81.44.844.8298

Visit [www.macom.com](http://www.macom.com) for additional data sheets and product information.

M/A-COM Inc. and its affiliates reserve the right to make changes to the product(s) or information contained herein without notice.

**MASW-005102-13600**

**HMIC™ Silicon PIN Diode Switch  
with Integrated Bias Network**

**RoHS Compliant**

**M/A-COM Products**

## Wire/Ribbon and Die Attachment Recommendations

### Cleanliness

These chips should be handled in a clean environment.

### Wire Bonding

Thermosonic wedge wire bonding using 0.00025" x 0.003" ribbon or 0.001" diameter gold wire is recommended. A heat stage temperature of 150°C and a force of 18 to 22 grams should be used. Ultrasonic energy should be adjusted to the minimum required to achieve a good bond. RF bond wires should be kept as short and straight as possible.

### Mounting

The HMIC switches have Ti-Pt-Au back metal. They can be die mounted with a gold-tin eutectic solder preform or conductive epoxy. Mounting surface must be clean and flat.

### Eutectic Die Attachment

An 80/20, gold-tin, eutectic solder preform is recommended with a work surface temperature of 255°C and a tool tip temperature of 265°C. When hot gas is applied, the tool tip temperature should be 290°C. The chip should not be exposed to temperatures greater than 320°C for more than 20 seconds. No more than three seconds should be required for attachment. Solders containing tin should not be used.

### Epoxy Die Attachment

A minimum amount of epoxy should be used. A thin epoxy fillet should be visible around the perimeter of the chip after placement. Cure epoxy per manufacturer's schedule. (typically 125-150°C).

## Ordering Information

Part Number	Package
<b>MASW-005102-13600W</b>	<b>Waffle Pack</b>

**ADVANCED:** Data Sheets contain information regarding a product M/A-COM is considering for development. Performance is based on target specifications, simulated results, and/or prototype measurements. Commitment to develop is not guaranteed.

**PRELIMINARY:** Data Sheets contain information regarding a product M/A-COM has under development. Performance is based on engineering tests. Specifications are typical. Mechanical outline has been fixed. Engineering samples and/or test data may be available. Commitment to produce in volume is not guaranteed.

- **North America** Tel: 800.366.2266 / Fax: 978.366.2266
- **Europe** Tel: 44.1908.574.200 / Fax: 44.1908.574.300
- **Asia/Pacific** Tel: 81.44.844.8296 / Fax: 81.44.844.8298

Visit [www.macom.com](http://www.macom.com) for additional data sheets and product information.

*M/A-COM Inc. and its affiliates reserve the right to make changes to the product(s) or information contained herein without notice.*